

DIGITAL VOICE RECORDER

**VN-120
VN-240
VN-480
VN-120PC
VN-240PC
VN-480PC**

EN INSTRUCTIONS

Thank you for purchasing an Olympus Digital Voice Recorder.

Please read these instructions for information about using the product correctly and safely. Keep the instructions handy for future reference.

To ensure successful recordings, we recommend that you test the record function and volume before use.

OLYMPUS CORPORATION
Shinjuku Monolith, 3-1 Nishi-Shinjuku 2-chome, Shinjuku-ku, Tokyo 163-0914, Japan. Tel. 03-3340-2111

OLYMPUS AMERICA INC.
Two Corporate Center Drive, Melville, NY 11747-3157, U.S.A. Tel. 1-800-622-6372

OLYMPUS EUROPA GMBH
(Premises/Goods delivery) Wendenstrasse 14-18, 20097 Hamburg, Germany. Tel. 040-237730
(Letters) Postfach 10 49 08, 20034 Hamburg, Germany.

OLYMPUS UK LTD.
2-8 Honduras Street, London EC1W 0TX, United Kingdom, Tel. 020-7253-2772
http://www.olympus.com

Identification of Parts

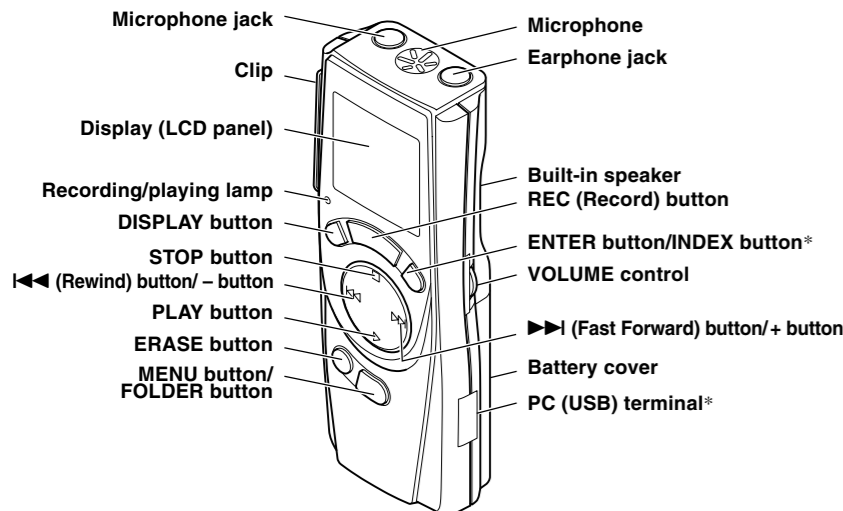

* INDEX button....VN-240/VN-240PC/VN-480/VN-480PC
PC (USB) terminal....VN-120PC/VN-240PC/VN-480PC

Getting Started

Inserting Batteries

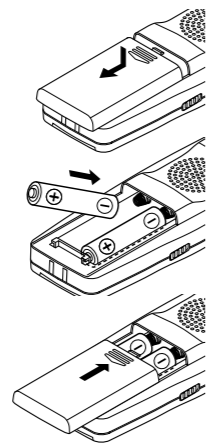

- 1 Lightly press down on the arrow and slide the battery cover open.
- 2 Insert two size-AAA alkaline batteries, observing the correct polarity.
- 3 Close the battery cover completely. Time/Date screen appears. The hour indicator flashes, indicating the start of the Time/Date setup process. (See "Setting Time/Date" for details)

An optional Ni-MH Rechargeable Battery from Olympus can be used for the recorder.

Replacing Batteries

When appears on the display, replace the batteries as soon as possible. Size-AAA alkaline batteries are recommended. When the batteries are depleted, appears on the display, and the recorder shuts off. It is recommended to set the HOLD switch to the HOLD position before you replace batteries to maintain the current settings (time/date, etc.). For your convenience, the recorder also logs the current settings in nonvolatile memory at hourly intervals.

Standby Mode and Display Shut Off

If the recorder is stopped or paused for 60 minutes or longer during recording or playing, it goes into Standby (power-save) mode, and the display shuts off. To exit Standby mode and turn on the display, press any button.

Setting Time/Date (TIME)

If you have set the time and date, information as to when a sound file was recorded is stored automatically with that file. The time and date must be set to enable management of files in folder S (VN-240/VN-240PC/VN-480/VN-480PC), for the alarm playback function, and for the timer recording (VN-480/VN-480PC).

When you install batteries for the first time or each time you replace the batteries, the hour indication will flash. In such a case, be sure to set the time and date by following steps 5 through 9 described below.

- 1 Press and hold the MENU button for 1 second or longer.
- 2 Press the STOP or PLAY button until "TIME" flashes on the display.
- 3 Press the ENTER button. The hour indicator flashes.
- 4 Press the STOP or PLAY button to set the hour.
- 5 Press the ENTER button to accept the minute. The minute indicator flashes. Pressing the - button enables the hour setting again.
- 6 Press the STOP or PLAY button to set the minute. Repeat steps 5 and 6 to continue to set the year, month and date in the same way.
- 7 After setting the date, press the ENTER button. This completes the time/date setup procedure.
- 8 Press the MENU button.

- You can switch the time indication between the 12-hour system and the 24-hour system by pressing the DISPLAY button while you are setting the hour or minute.
- You can change the order of the date indication by pressing the DISPLAY button while you are setting the year, month, or day. (Example: February 14, 2004)

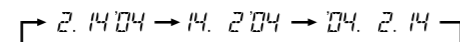

Hold

Set the HOLD switch to the HOLD position. All operation buttons are disabled. This feature is useful when the recorder has to be carried in a handbag or pocket. Remember to reset the HOLD switch before attempting to use the recorder.

- Notes**
- The alarm will sound at the scheduled time even if the recorder is set to HOLD. The recorder will then begin to play the file associated with the alarm once you press any button.
 - The recorder functions as follows with the HOLD switch set to the HOLD position:
 - If the recorder is playing, the display goes dark when playback of the current file has completed.
 - When you set the HOLD switch to the HOLD position while playing back, you can still adjust the volume using the VOLUME control.
 - If the recorder is recording, the display goes dark when the recorder stops recording automatically upon running out of free memory.

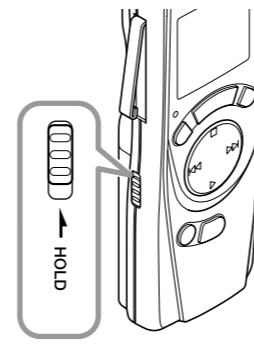

Clip

How to Use the Clip

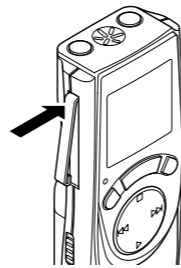

- Press the area that the arrow points to.
- Do not force the clip wider, as it may break.

Notes on the Folders

The recorder has four folders: A, B, C, and S. To change the folder selection, press the FOLDER button while the recorder is stopped.

- Folders A, B, and C: Each recorded file is stored in a folder. Using folders to classify files makes it convenient to find files you want to access later.
- Folder S (VN-240/VN-240PC/VN-480/VN-480PC): This folder has date subfolders* from January 1 to December 31. Up to 10 files can be stored in each date subfolder, a useful feature for schedule management by storing a certain day's schedule for future reference. To switch between date subfolders, select the S folder, then press the + or - button while the recorder is stopped. Up to a total of 100 files can be recorded in folder S. * There is one subfolder for each day of the year.

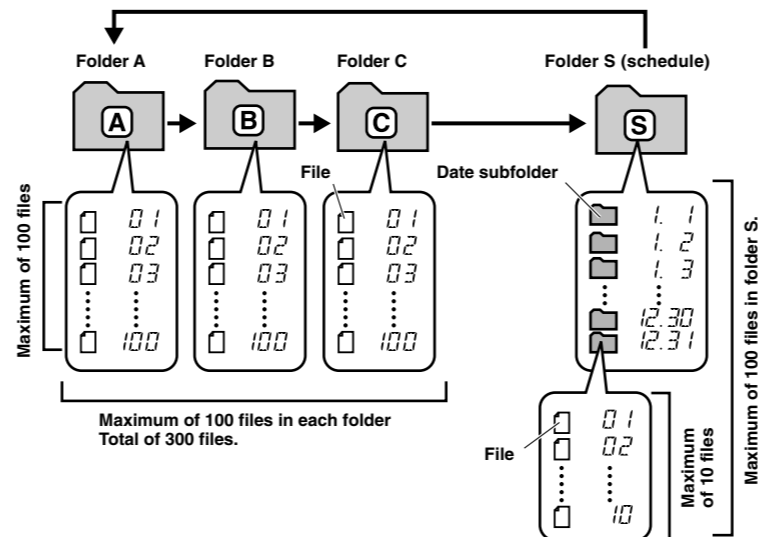

Recording

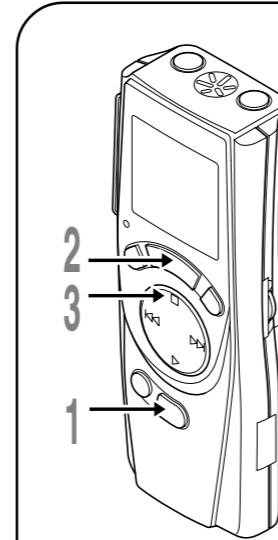

- 1 Press the FOLDER button to select the desired folder (A, B, C or S). When you select folder S, the current date subfolder appears on the display.
 - If you select folder S, press the + or - button to select the desired date subfolder.
- 2 Press the REC button to start recording. The Recording/playing lamp turns red, and recording starts.
- 3 To stop recording, press the STOP button. New recordings are saved as the last file in the folder.

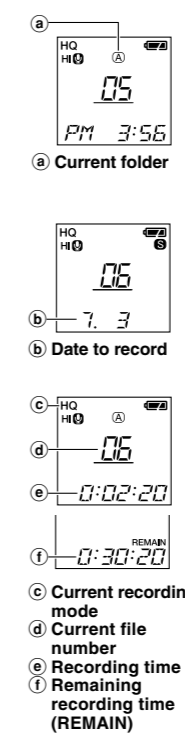

To Pause Recording

To pause
Press the REC button during recording. "PAUSE" appears on the display and the Recording/playing lamp flashes.

To resume recording
Press the REC button again. Recording will resume at the point of interruption.

Notes

- If "FULL" appears on the display, you cannot record in the selected folder. In such a case, erase unnecessary files or download to PC (VN-120PC/VN-240PC/VN-480PC).
- If the recorder is placed directly on a table when recording a meeting, it tends to pick up table vibrations. Put a notebook or other item between the table and the recorder for clearer recording.
- Even if you press the DISPLAY button, the display will not change to current recording time if the remaining recording time is 5 minutes or less.
- When remaining recording time falls to 1 minute or less, the Recording/playing lamp flashes red.
- The recorder will enter Stop mode if it has been left paused for 10 minutes or longer.
- In case of difficult acoustic conditions or low speaker's voice, recording in HQ or SP is recommended. Also, usage of an external microphone (sold separately) could improve the quality of recordings.

LCD Display Information

You can select an option for the display of the recorder. This help review and confirm different recorder settings and file information.

State of the recorder	Operation	Display
While in Stop mode	Press and hold the STOP button	The total number of files recorded in the folder and remaining recording time appears on the display.
	Press the DISPLAY button	Time → Remaining recording time → Date → Time . . . (with folder A, B or C selected) The selected indication appears on the display each time the recorder is stopped.
While in record mode	Press the DISPLAY button	The display switches between current recording time and remaining recording time.
While in playback mode	Press the DISPLAY button	Playing time → Remaining playing time → Recording date of the file → Recording time of the file → Playing time . . .

Playing Back

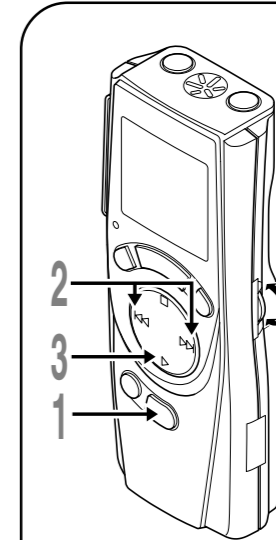

- 1 Press the FOLDER button to select the desired folder (A, B, C or S).
- 2 Press the + or - button to select the file to play back. If you select folder S, select the desired date subfolder.
 - When you select the desired date subfolder, it is useful to press and hold the + or - button for 1 second or longer. The recorder locates the next date subfolder that contains recorded files.
- 3 Press the PLAY button to start playback. The Recording/playing lamp turns green, and the elapsed playing time is indicated on the display.
- 4 Use the VOLUME control to adjust the volume to your liking.

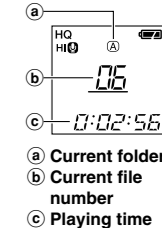

Canceling Playback

- To stop**
Press the STOP button. The recorder stops in the middle of the file being played.
- To resume playback**
Press the PLAY button again. Playback will resume at the point of interruption.

When you play back a file in the date subfolder without choosing a specified file, the recorder will play back all the files in the selected date subfolder from filename "01". When you play back a file immediately after recording the file, only the most recently recorded file will be played back.

Forwarding and Rewinding

- Fast Forward**
Press and hold the <fast forward> button while playing a file. When you release the <fast forward> button, the recorder will resume normal playback.
- Rewind**
Press and hold the <rewind> button while playing a file. When you release the <rewind> button, the recorder will resume normal playback.

- No sound is heard from the built-in speaker during fast forwarding or rewinding.
- The end of the file is located by pressing and holding the <fast forward> button during fast forwarding. The recorder will pause at the end of the file. If you do not release the <fast forward> button, the recorder will continue fast forward.
- The beginning of the file is located by pressing and holding the <rewind> button during rewinding. The recorder will pause at the beginning of the file. If you do not release the <rewind> button, the recorder will continue rewinding.

Changing Playing Speed

You can change the playing speed by pressing the PLAY button while the recorder is playing back.

Normal speed → Slow playback (-20%) → Fast playback (+30%)

- When the slow playback mode is selected, the "SLOW" appears and, for the fast playback mode, "FAST" appears on the display while the recorder is playing back.
- The recorder stops playing when you press the STOP button while playing back in the slow/fast mode, or when it reaches to the end of the file. If you once press the STOP button and start playback again, the recorder will play back files in normal speed as well.

Locating the beginning of the file

While the recorder is playing back in the slow/fast mode, pressing the + or - button forwards or rewinds to the beginning of the previous or next file respectively. If an index mark is encountered midway, playback begins at that point. (See "Index Marks" for details)

Listening with earphones

You can listen to files by connecting earphones to the earphone jack. If an earphone is connected, the speaker doesn't emit sound. Sound will be played back monaurally.

* An earphone is not provided with VN-120, VN-120PC, VN-240 and VN-480. You can use any standard 3.5mm monaural earphone or headphone.

Erasing from Folder A, B or C

You can easily erase unnecessary files. Sequential file numbers are reassigned automatically.

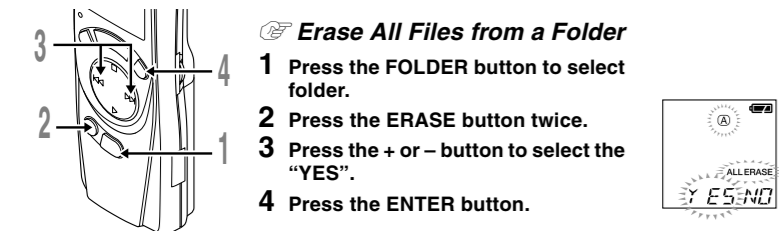
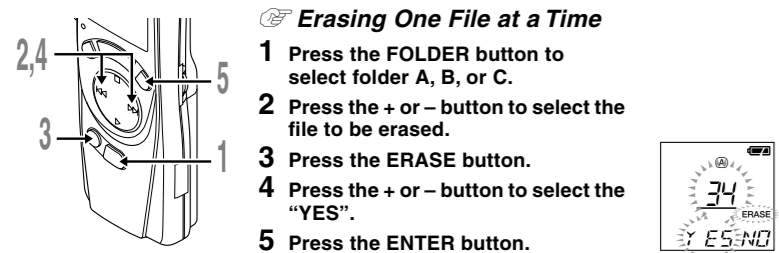

Note
If you leave the recorder untouched for 8 seconds or longer before you press the ENTER button, Clear mode will be canceled, and the recorder will enter Stop mode.

Erasing from Folder S

(VN-240/VN-240PC/VN-480/VN-480PC)

To erase S folder, select S folder, and then press the ERASE button repeatedly to select your desired erasing mode. Each time you press the ERASE button, the erasing mode changes in the following order: by file → by date → by month → by folder → disabled.

Erasing One File at a Time in a Date Subfolder

- 1 Press the FOLDER button to select the folder S.
- 2 Press the + or - button to select the date subfolder.
- 3 Press the PLAY button.
- 4 Press the + or - button to select the file to be erased.
- 5 Press the STOP button.
- 6 Press the ERASE button.
- 7 Press the + or - button to select the "YES".
- 8 Press the ENTER button.

Sequential file numbers are reassigned automatically.

Erase All Files in a Date Subfolder

- 1 Press the FOLDER button to select the folder S.
- 2 Press the + or - button to select the date subfolder to be erased.
- 3 Press the ERASE button twice.
- 4 Press the + or - button to select the "YES".
- 5 Press the ENTER button.

Erase All Files in a Month Subfolder

- 1 Press the FOLDER button to select the folder S.
- 2 Press the ERASE button three times.
- 3 Press the STOP or PLAY button to select the month subfolder to be erased.
- 4 Press the ENTER button.
- 5 Press the + or - button to select the "YES".
- 6 Press the ENTER button.

Erase All Files in the S Folder

- 1 Press the FOLDER button to select the folder S.
- 2 Press the ERASE button four times.
- 3 Press the + or - button to select the "YES".
- 4 Press the ENTER button.

Note
If you leave the recorder untouched for 8 seconds or longer before you press the ENTER button, Clear mode will be canceled, and the recorder will enter Stop mode.

Using the menu function, you can change various settings according to your preference.

Basic operation of the menu mode

- 1 Press and hold the MENU button for 1 second or longer while the recorder is stopped.
- 2 Press the STOP or PLAY button to select what you would like to set up.
- 3 Use the + or - button to change the setting.
- 4 Press the ENTER button to confirm the setting.
- 5 Press the MENU button to close the menu.

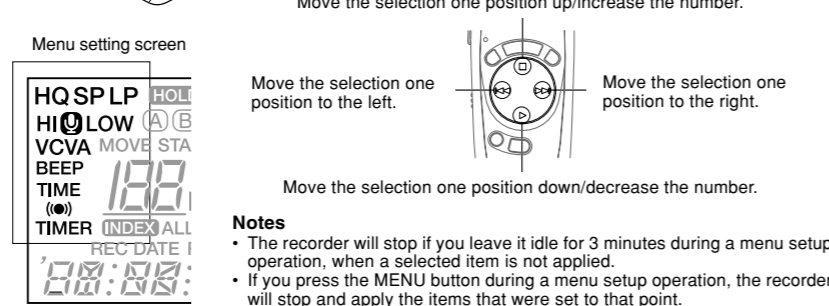

Recording Modes (HQ SP LP)

You can select from among three recording modes: HQ (High Quality) mode, SP (Standard Playback) mode and LP (Long Playback) mode.

In Menu mode selection... HQ, SP, LP

Mode	Model	VN-120 / VN-120PC	VN-240 / VN-240PC	VN-480 / VN-480PC
HQ		Approx.43min	Approx.88min	Approx.177min
SP		Approx.65min	Approx.133min	Approx.267min
LP		Approx.121min	Approx.245min	Approx.493min

The recording time shown above is for one continuous file. The available recording time may be shorter than specified if several files are recorded. (Use the remaining time and recorded time only as references.)

Microphone Sensitivity (HI @ LOW)

Microphone sensitivity is adjustable to meet your recording needs.

In Menu mode selection... HI, LOW

HI: High-sensitivity mode that records sounds in all directions.
LOW: Low-sensitivity mode suited for dictation.

- To ensure successful recording, make a test recording to choose appropriate microphone sensitivity before recording.
- If you choose HI, we recommend setting the recording mode to HQ or SP to best take advantage of the higher sensitivity.
- If you choose HI, background noise may be high depending on the recording conditions.

Using The Variable Control Voice Actuator (VCVA)

When the microphone senses that sounds have reached a preset volume, the built-in Variable Control Voice Actuator (VCVA) starts recording automatically, and stops it when the volume drops. Particularly helpful for extended recording, the VCVA not only conserves memory by turning off recording during silent periods, but also makes playback more efficient and convenient.

In Menu mode selection... ON, OFF

The Recording/playing lamp is lit during recording. When the recorder is in Standby mode, the Recording/playing lamp flashes and "VCVA" flashes on the display.

System Sounds (BEEP)

The recorder beeps to alert you to button operations or warn you of errors. System sounds may be turned off.

In Menu mode selection... ON, OFF

If the alarm playback function has been set, the alarm will sound at the scheduled time even if the system sounds are disabled.

Alarm Playback Function ((●))

You can use the alarm playback function to sound the alarm tone for 5 minutes at the scheduled time. Within this 5 minutes, pressing any button other than the HOLD switch starts the recorder to play back the pre-selected file.

In Menu mode selection... SET, ON, OFF→After selecting SET, press the ENTER button to set the time.

With the alarm playback function, only one file can be played back. Select a file for the function before setting the time. For S folder, all files contained in the selected date subfolder are played back.

To cancel an alarm playback

For (●) in the menu mode, select OFF and press the ENTER button.

- Regardless of the selected folder, once the alarm playback is set, it operates every day unless the setting is canceled.
- To view the current setting, select ON, and then press the ENTER button.
- The alarm tone stops automatically if no button is pressed within 5 minutes after the alarm starts. The file is not played back in this case.
- If the recorder has no recorded file in the selected folder, the alarm playback function is not available.
- Alarm playback occurs every day unless it is set to OFF.
- Even if no file is recorded in the day's date subfolder, the beeps will sound. In such a case, no sound is heard even if you press some button while the alarm is sounding.

Timer Recording (TIMER) (VN-480/VN-480PC)

You can schedule for automatic recording, specifying the start time and end time of recording. When the timer-controlled recording completes, the setting is released.

In Menu mode selection... SET, ON, OFF→After selecting SET, press the ENTER button to set the time.

To cancel the timer setting

For the timer in the menu mode, select OFF, and then press the ENTER button.

- To view the current setting, select ON, and then press the ENTER button.
- With this function, you can set only the start and the end time of recording. The current settings of the recording mode, microphone sensitivity, VCVA and folder are applied for the settings before you set timer-controlled recording.
- The setting exceeding the remaining recording time is not allowed.
- You can record at any time even it is not within the specified recording duration. However, if that makes the remaining recording time insufficient for the timer-controlled recording, the recording will not complete.
- If any operation is ongoing, the timer-controlled recording is overridden.

Resetting the Recorder (CLEAR)

This function resets the current time and other settings to their initial status. It is useful if you are having problems with the recorder, or if you want to erase the entire memory of the recorder.

- 1 Hold the STOP button, and hold the ERASE button for 3 seconds or longer.
- 2 Press the + or - button to select the "YES".
- 3 Press the ENTER button.

Note

If you leave the recorder untouched for 8 seconds or longer before you press the ENTER button in Step 3, Clear mode will be canceled, and the recorder will enter Stop mode.

General Precautions

Read this manual carefully to ensure that you know how to operate it safely and correctly. Keep this manual in an easily accessible location for future reference.

The warning symbols indicate important safety related information. To protect yourself and others from personal injury or damage to property, it is essential that you always read the warnings and information provided.

Warning regarding data loss

Recorded content in memory may be destroyed or erased by operating mistakes, unit malfunction, or during repair work. For important recorded content, we recommend you to write it down somewhere (for VN-120/VN-240/VN-480) or make a back-up by downloading to a PC (for VN-120PC/VN-240PC/VN-480PC).

For safe And Correct Usage

- Do not leave the recorder in hot, humid locations such as inside a closed automobile under direct sunlight or on the beach in the summer.
- Do not store the recorder in places exposed to excessive moisture or dust.
- Do not use organic solvents such as alcohol and lacquer thinner to clean the unit.
- Do not place the recorder on top of or near electric appliances such as TVs or refrigerators.
- Avoid sand or dirt. These can cause irreparable damage.
- Avoid strong vibrations or shocks.
- Do not disassemble, repair or modify the unit yourself.
- Do not operate the unit while operating a vehicle (such as a bicycle, motorcycle, or go-cart).
- Keep the unit out of the reach of children.

Batteries

Warning

- Batteries should never be exposed to flame, heated, short-circuited or disassembled.
- Do not attempt to recharge alkaline, lithium or any other non-rechargeable batteries.
- Never use any battery with a torn or cracked outer cover.
- Keep batteries out of the reach of children.
- If you notice anything unusual when using this product such as abnormal noise, heat, smoke, or a burning odor:
 - 1 remove the batteries immediately while being careful not to burn yourself, and;
 - 2 call your dealer or local Olympus representative for servicing.

Troubleshooting

Q1 Nothing happens when a button is pressed.

- A1
- The HOLD button may be set to HOLD.
 - The batteries may be depleted.
 - The batteries may be inserted incorrectly.

Q2 No sound or quiet sound is heard from the speaker while playing back.

- A2
- The earphone plug may be plugged into the recorder.
 - The volume may be set to the minimum level.

Q3 Recording is not possible.

- A3
- By pressing the STOP button repeatedly while the recorder stops, check if the display shows:
 - The remaining recording time in the selected folder may have reached "00:00".
 - The number of files is 100
 - Check if the display shows FULL by pressing the REC button. The number of files of the same date in folder S may have reached 10.

Q4 The playback speed is too fast (slow).

- A4
- The recorder may be set to Fast (slow) Playback.

Q5 The remaining recording time seems too short.

- A5
- Some files may be stored in the S folder. Hold the STOP button while in the S folder. The display will show the total number of recordings in the S folder.

Q6 You cannot move the file.

- A6
- The number of recorded files in the destination folder may have reached 100.
 - Make sure that you haven't transferred to or from the S folder.

Recording medium: Built-in flash memory
Recording time: VN-120 (16 MB) / VN-120PC (16 MB)

HQ mode: Approx. 43 min
SP mode: Approx. 65 min
LP mode: Approx. 121 min
VN-240 (32 MB) / VN-240PC (32 MB)
HQ mode: Approx. 88 min
SP mode: Approx. 133 min
LP mode: Approx. 245 min
VN-480 (64 MB) / VN-480PC (64 MB)
HQ mode: Approx. 177 min
SP mode: Approx. 267 min
LP mode: Approx. 493 min

Microphone: Electret Condenser Microphone (monaural)
Speaker: Built-in ø 28 mm round dynamic speaker
Maximum power: 120 mW
Earphone jack (monaural): ø 3.5 mm diameter, impedance 8 Ω
Microphone jack (monaural): ø 3.5 mm diameter, impedance 2 kΩ
Power supply: Two AAA (LR03 or R03) batteries or Two Ni-MH rechargeable batteries

Continuous battery use time: Alkaline batteries: About 25 hours

Ni-MH rechargeable batteries: About 19 hours
Dimensions: 99 (L) × 39 (W) × 21.5 (T) mm
Weight: VN-120/VN-240/VN-480: 66.5 g (including batteries)
VN-120PC/VN-240PC/VN-480PC: 68 g (including batteries)

* Battery life is measured by Olympus. It varies greatly according to the type of batteries used and the conditions of use.

* Your recorded contents are for your personal use or pleasure only. It is prohibited to record copyrighted material without permission of the copyright holders according to copyright law.

* Specifications and design are subject to change without notice for improvement of performance.

Accessories (Optional)

Ni-MH Rechargeable Battery Charger: BU-400
Ni-MH Rechargeable Battery: BR401
Connecting cord (Earphone jack ↔ Microphone jack): KA232*
Plug adapter (Mini miniplug → Miniplug): PA3
Noise-Cancellation microphone: ME12
Electret condenser microphone: ME10
Headset: E99
Telephone pickup: TP6

Accessories marked* should be used in combination with the PA3 plug adapter.

USA RFI

This equipment has been tested and found to comply with the limits for a Class B digital device, pursuant to part 15 of the FCC Rules. These limits are designed to provide reasonable protection against harmful interference in a residential installation. This equipment generates, uses and can radiate radio frequency energy and, if not installed and used in accordance with the instructions, may cause harmful interference to radio communications. However, there is no guarantee that interference will not occur in a particular installation. If this equipment does cause harmful interference to radio or television reception, which can be determined by turning the equipment off and on, the user is encouraged to try to correct the interference by one or more of the following measures:

- Reorient or relocate the receiving antenna.
- Increase the separation between the equipment and receiver.
- Connect the equipment into an outlet on a circuit different from that to which the receiver is connected.
- Consult the dealer or an experienced radio/TV technician for help.

Canadian RFI

This digital apparatus does not exceed the Class B limits for radio noise emissions from digital apparatus as set out in the Radio Interference Regulations of the Canadian Department of Communications.

Cet appareil numérique ne dépasse pas les limites de Catégorie B pour les émissions de bruit radio émanant d'appareils numériques, tel que prévu dans les Règlements sur l'Interférence Radio du Département Canadien des Communications.



"CE" mark indicates that this product complies with the European requirements for safety, health, environment and customer protection. L'indication "CE" signifie que ce produit est conforme aux exigences concernant la sécurité, la santé, l'environnement et la protection du consommateur.



Das „CE“ Zeichen bestätigt die Übereinstimmung mit den Europäischen Bestimmungen für Betriebssicherheit und Umweltschutz.



Il marchio "CE" indica che questo prodotto è conforme alle norme della comunità europea per quanto riguarda la sicurezza, la salute, l'ambiente e la protezione del consumatore.



La marca "CE" indica que este producto se encuentra de conformidad con las exigencias europeas sobre seguridad, salud, medio ambiente y protección al consumidor.